

Inscribed Angles CW

State if each angle is an inscribed angle. If it is, name the angle and the intercepted arc.

1)

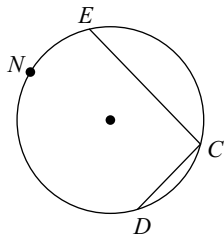

2)

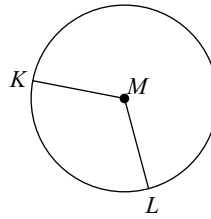

3)

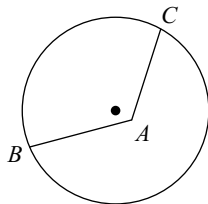

4)

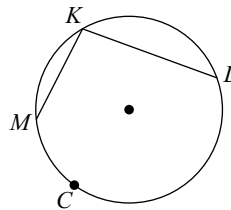

Find the measure of the arc or angle indicated.

5)

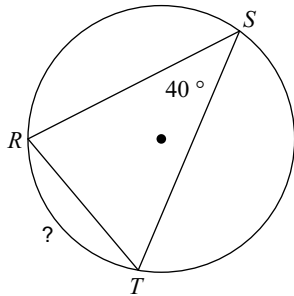

6)

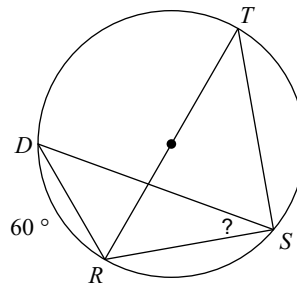

7)

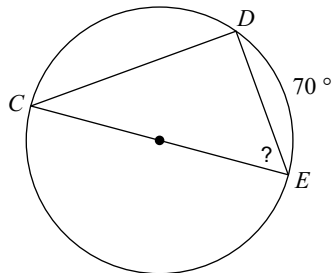

8)

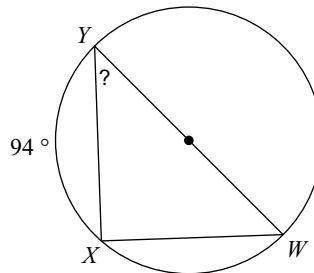

9)

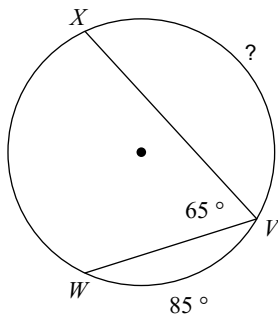

10)

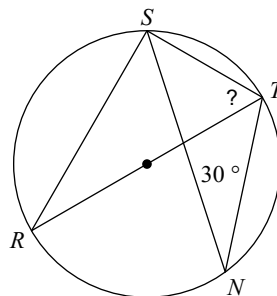

11)

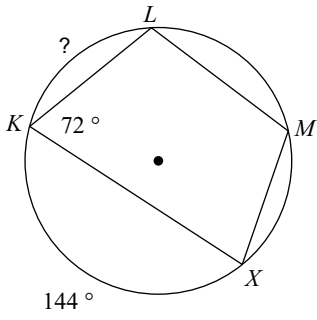

12)

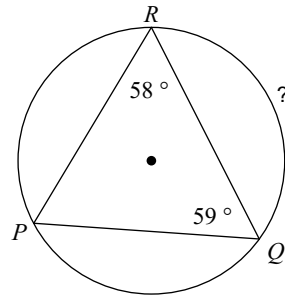

13)

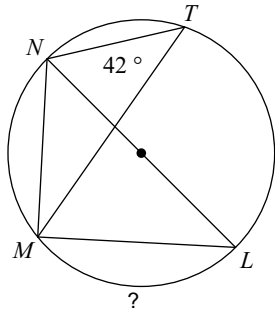

14)

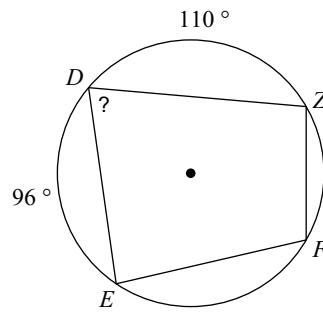

Solve for x .

15)

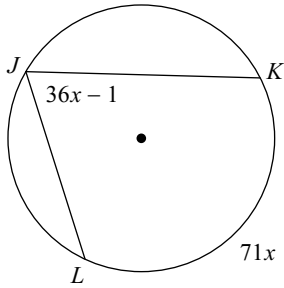

16)

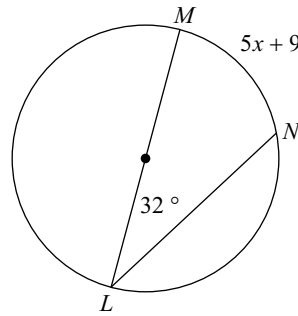

17)

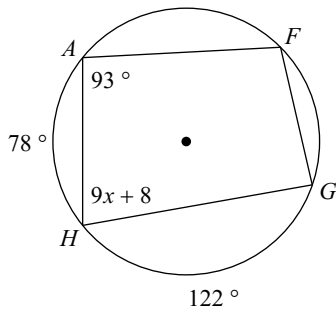

18)

